



FLIR E8 (incl. Wi-Fi)

P/N: 63908-0805

Copyright

© 2017, FLIR Systems, Inc.

All rights reserved worldwide. Names and marks appearing herein are either registered trademarks or trademarks of FLIR Systems and/or its subsidiaries. All other trademarks, trade names or company names referenced herein are used for identification only and are the property of their respective owners.

Document identity

Publ. No.: 63908-0805
 Release:
 Commit: 40600
 Language: en-US
 Modified: 2017-02-27
 Formatted: 2017-02-27

Website

<http://www.flir.com>

Customer support

<http://support.flir.com>

Disclaimer

Specifications subject to change without further notice. Camera models and accessories subject to regional market considerations. License procedures may apply. Products described herein may be subject to US Export Regulations. Please refer to exportquestions@flir.com with any questions.



| | |
|---|--|
| General description | |
| <p>The FLIR Ex series cameras are point-and-shoot infrared cameras that give you access to the infrared world. A FLIR Ex series camera is an affordable replacement for an infrared thermometer, providing a thermal image with temperature information in every pixel. The new MSX and visual formats make the cameras incomparably easy to use.</p> <p>The FLIR Ex series cameras are user-friendly, compact, and rugged, for use in harsh environments. The wide field of view makes them the perfect choice for building applications.</p> | |
| Benefits: | |
| <ul style="list-style-type: none"> • Easy to use: The FLIR Ex series cameras are fully automatic and focus-free with an intuitive interface for simple measurements in thermal, visual, or MSX mode. • Compact and rugged: The FLIR Ex series cameras' low weight of 0.575 kg and the accessory belt pouch make them easy to bring along at all times. Their rugged design can withstand a 2 m drop test, and ensures reliability, even in harsh environments. • Ground breaking affordability: The FLIR Ex series cameras are the most affordable infrared cameras on the market. | |
| Imaging and optical data | |
| IR resolution | 320 × 240 pixels |
| Thermal sensitivity/NETD | <0.06°C (0.11°F) / <60 mK |
| Field of view (FOV) | 45° × 34° |
| Minimum focus distance | 0.5 m (1.6 ft.) |
| Spatial resolution (IFOV) | 2.6 mrad |
| F-number | 1.5 |
| Image frequency | 9 Hz |
| Focus | Focus free |
| Detector data | |
| Detector type | Focal plane array (FPA), uncooled microbolometer |
| Spectral range | 7.5–13 μm |
| Image presentation | |
| Display | 3.0 in. 320 × 240 color LCD |
| Image adjustment | Automatic/Manual |



FLIR E8 (incl. Wi-Fi)

P/N: 63908-0805

© 2017, FLIR Systems, Inc.

#63908-0805; r. /40600; en-US

| Image presentation modes | |
|---|---|
| Image modes | Thermal MSX, Thermal, Picture-in-Picture, Thermal blending, Digital camera. |
| Multi Spectral Dynamic Imaging (MSX) | IR image with enhanced detail presentation |
| Picture-in-Picture | IR area on visual image |
| Measurement | |
| Object temperature range | -20°C to +250°C (-4°F to +482°F) |
| Accuracy | ±2°C (±3.6°F) or ±2% of reading, for ambient temperature 10°C to 35°C (+50°F to 95°F) and object temperature above +0°C (+32°F) |
| Measurement analysis | |
| Spotmeter | Center spot |
| Area | Box with max./min. |
| Isotherm | Above/below/interval |
| Emissivity correction | Variable from 0.1 to 1.0 |
| Emissivity table | Emissivity table of predefined materials |
| Reflected apparent temperature correction | Automatic, based on input of reflected temperature |
| Set-up | |
| Color palettes | Black and white, iron and rainbow |
| Set-up commands | Local adaptation of units, language, date and time formats |
| Storage of images | |
| File formats | Standard JPEG, 14-bit measurement data included |
| Digital camera | |
| Digital camera, resolution | 640 × 480 |
| Digital camera, FOV | 55° × 43° |
| Data communication interfaces | |
| Interfaces | USB Micro: Data transfer to and from PC and Mac device |
| Wi-Fi | Peer-to-peer (ad hoc) or infrastructure (network) |
| Radio | |
| Wi-Fi | <ul style="list-style-type: none"> • Standard: 802.11 b/g/n • Frequency range: <ul style="list-style-type: none"> ◦ 2400–2480 MHz ◦ 5150–5260 MHz • Max. output power: 15 dBm |
| Power system | |
| Battery type | Rechargeable Li ion battery |
| Battery voltage | 3.6 V |
| Battery operating time | Approx. 4 hours at +25°C (+77°F) ambient temperature and typical use |
| Charging system | Battery is charged inside the camera or in specific charger. |



FLIR E8 (incl. Wi-Fi)

P/N: 63908-0805

© 2017, FLIR Systems, Inc.

#63908-0805; r./40600; en-US

| Power system | |
|----------------------|--|
| Charging time | 2.5 hours to 90% capacity in camera. 2 hours in charger. |
| Charging temperature | 10°C to +45°C (+50°F to +113°F) |
| Power management | Automatic shut-down |
| AC operation | AC adapter, 90–260 VAC input, 5 VDC output to camera |

| Environmental data | |
|----------------------------------|---|
| Operating temperature range | –15°C to +50°C (+5°F to +122°F) |
| Storage temperature range | –40°C to +70°C (–40°F to +158°F) |
| Humidity (operating and storage) | IEC 60068-2-30/24 h 95% relative humidity |
| EMC | <ul style="list-style-type: none">• WEEE 2012/19/EC• RoHs 2011/65/EC• C-Tick• EN 61000-6-3• EN 61000-6-2• FCC 47 CFR Part 15 Class B |
| Radio spectrum | <ul style="list-style-type: none">• ETSI EN 300 328• FCC 47 CSR Part 15• RSS-247 Issue 1 |
| Encapsulation | IP 54 (IEC 60529) |
| Shock | 25 g (IEC 60068-2-27) |
| Vibration | 2 g (IEC 60068-2-6) |
| Drop | 2 m (6.6 ft.) |

| Physical data | |
|------------------------------|---|
| Camera weight, incl. battery | 0.575 kg (1.27 lb.) |
| Camera size (L × W × H) | 244 × 95 × 140 mm (9.6 × 3.7 × 5.5 in.) |
| Color | Black and gray |

| Certifications | |
|----------------|--------------------------|
| Certification | UL, CSA, CE, PSE and CCC |

| Shipping information | |
|----------------------|--|
| Packaging, type | Cardboard box |
| List of contents | <ul style="list-style-type: none">• Infrared camera• Hard transport case• Battery (2x)• USB cable• Power supply/charger with EU, UK, US and Australian plugs• Battery charger• Printed documentation |
| Packaging, weight | 3.13 kg (6.9 lb.) |
| Packaging, size | 385 × 165 × 315 mm (15.2 × 6.5 × 12.4 in.) |
| EAN-13 | 4743254002890 |
| UPC-12 | 845188014148 |
| Country of origin | Estonia |

Supplies & accessories:

- T911093; Tool belt
- T198528; Hard transport case FLIR Ex-series



FLIR E8 (incl. Wi-Fi)

P/N: 63908-0805

© 2017, FLIR Systems, Inc.

#63908-0805; r. /40600; en-US

- T198530; Battery
- T198531; Battery charger incl power supply
- T198532; Car charger
- T198534; Power supply USB-micro
- T198529; Pouch FLIR Ex and ix series
- T198533; USB cable Std A <-> Micro B
- T199362ACC; Battery Li-ion 3.6 V, 2.6 Ah, 9.4 Wh
- T198583; FLIR Tools+ (download card incl. license key)
- T199233; FLIR Atlas SDK for .NET
- T199234; FLIR Atlas SDK for MATLAB

Camera with built-in IR lens f=6,5 mm (45°)

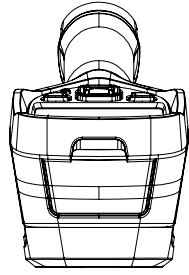
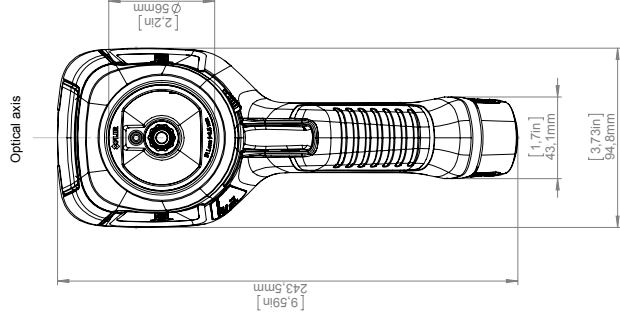
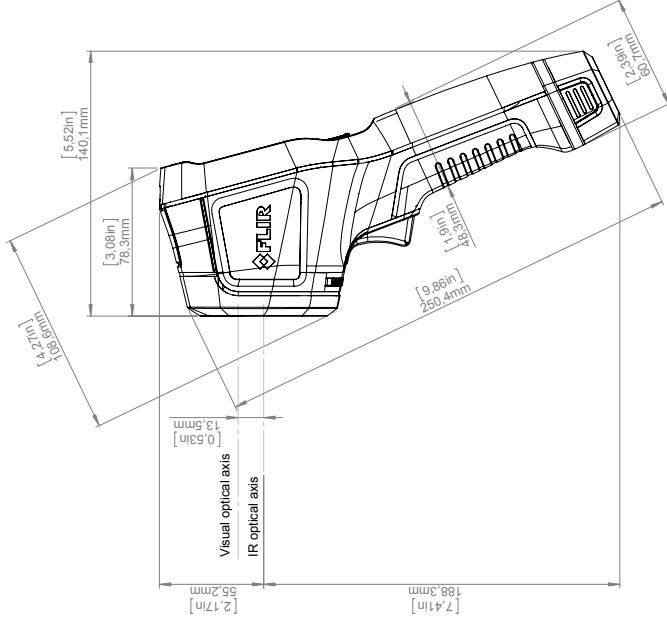
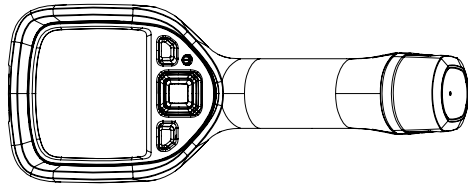
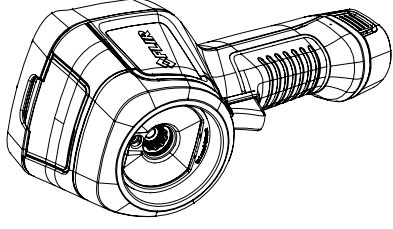
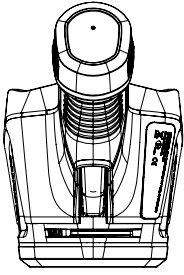

Charger and Power pack

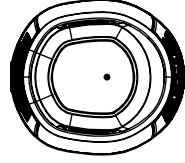
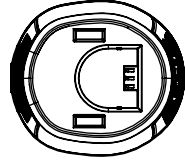
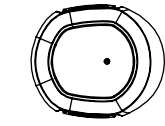
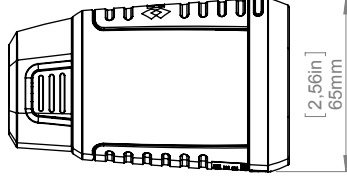
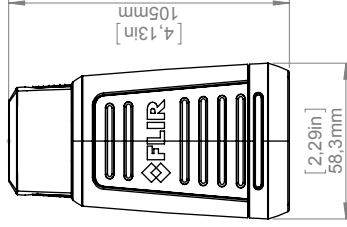
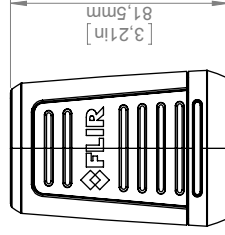
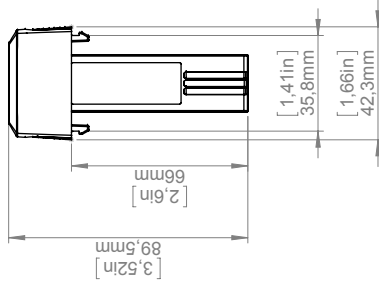
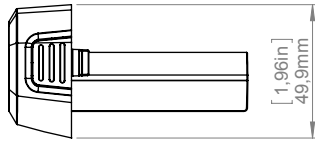
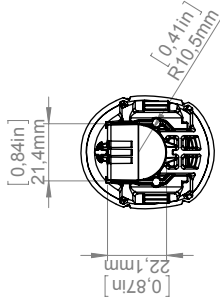
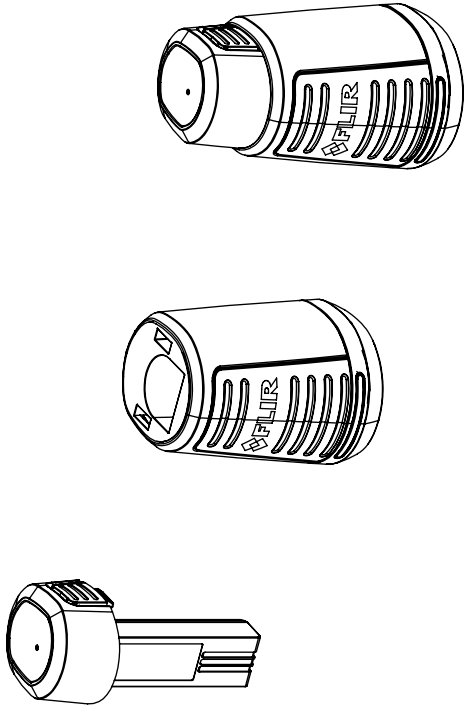

| | | |
|---|----------------------|---|
| | | Drawing No. T127831 Size A |
| Modified 2013-03-25 Denomination | Check CAHA | Drawn by R&D Thermography |
| Size A3 Scale 1:2 | | Sheet 2(2) Size A |
| Basic dimensions FLIR Ex | | |

© 2012, FLIR Systems, Inc. All rights reserved worldwide. No part of this drawing may be reproduced, stored in a retrieval system, or transmitted in any form, or by any means, electronic, mechanical, photocopying, recording, or otherwise, without written permission from FLIR Systems, Inc. Specifications subject to change without further notice. Dimensional data is based on nominal values. Products may be subject to regional market considerations. License procedures may apply. Product may be subject to US Export Regulations. Please refer to exportquestions@flir.com with any questions. Division contrary to US law is prohibited.



The World's Sixth Sense™

February 24, 2017 Täby, Sweden

AQ320224

CE Declaration of Conformity – EU Declaration of Conformity

Product: FLIR EX -series

Name and address of the manufacturer:

FLIR Systems AB

PO Box 7376

SE-187 15 Täby, Sweden

This declaration of conformity is issued under the sole responsibility of the manufacturer.

The object of the declaration: FLIR EX -series.

The object of the declaration described above is in conformity with the relevant Union harmonisation legislation:

Directives:

| | | |
|------------|------------|---|
| Directive | 2014/30/EU | Electromagnetic Compatibility |
| Directive | 2014/35/EU | Low Voltage Directive (Power Supply) |
| Directive | 2012/19/EU | Waste electrical and electric equipment |
| Directive: | 2011/65/EU | RoHS |
| Directive | 1999/5/EC | Radio and Telecommunications Terminal Equipment |

Standards:

| | | |
|-------------------------------|------------------------------------|---|
| Emission: | EN 61000-6-3/A1:2011 | Electromagnetic Compatibility Generic standards – Emission |
| Immunity: | EN 61000-6-2:2005 | Electromagnetic Compatibility Generic standards – Immunity |
| Restricted substances (RoHS): | EN 50581:2012 | Technical documentation |
| Radio: | ETSI EN 300 328 ETSI EN 301 893 | Harmonized EN covering essential requirements of the R&TTE Directive |
| Safety (Power supply): | EN 60950 | Information technology equipment |

FLIR Systems AB
Quality Assurance

Lea Dabiri
Quality Manager