

P/N: 63907-0804

Copyright

© 2019, FLIR Systems, Inc.

All rights reserved worldwide. Names and marks appearing herein are either registered trademarks or trademarks of FLIR Systems and/or its subsidiaries. All other trademarks, trade names or company names referenced herein are used for identification only and are the property of their respective owners.

Document identity

Publ. No.: 63907-0804

Commit: 55616

Language:

Modified: 2019-02-19

Formatted: 2019-02-19

Website

<http://www.flir.com>

Customer support

<http://support.flir.com>

Disclaimer

Specifications subject to change without further notice. Camera models and accessories subject to regional market considerations. License procedures may apply. Products described herein may be subject to US Export Regulations. Please refer to exportquestions@flir.com with any questions.



General description

The FLIR Ex series cameras are point-and-shoot infrared cameras that give you access to the infrared world. A FLIR Ex series camera is an affordable replacement for an infrared thermometer, providing a thermal image with temperature information in every pixel. The new MSX and visual formats make the cameras incomparably easy to use.

The FLIR Ex series cameras are user-friendly, compact, and rugged, for use in harsh environments. The wide field of view makes them the perfect choice for building applications.

Benefits:

- Easy to use: The FLIR Ex series cameras are fully automatic and focus-free with an intuitive interface for simple measurements in thermal, visual, or MSX mode.
- Compact and rugged: The FLIR Ex series cameras' low weight of 0.575 kg and the accessory belt pouch make them easy to bring along at all times. Their rugged design can withstand a 2 m drop test, and ensures reliability, even in harsh environments.
- Ground breaking affordability: The FLIR Ex series cameras are the most affordable infrared cameras on the market.

Imaging and optical data

IR resolution	240 × 180 pixels
Thermal sensitivity/NETD	< 0.06°C (0.11°F) / < 60 mK
Field of view (FOV)	45° × 34°
Minimum focus distance	0.5 m (1.6 ft.)
Spatial resolution (IFOV)	3.4 mrad
F-number	1.5
Image frequency	9 Hz
Focus	Focus free

Detector data

Detector type	Focal plane array (FPA), uncooled microbolometer
Spectral range	7.5–13 μm

Image presentation

Display	3.0 in. 320 × 240 color LCD
Image adjustment	Automatic/Manual



FLIR E6xt (incl. Wi-Fi)

P/N: 63907-0804

© 2019, FLIR Systems, Inc.

#63907-0804; r. 55616;

Image presentation modes	
Image modes	Thermal MSX, Thermal, Picture-in-Picture, Thermal blending, Digital camera.
Multi Spectral Dynamic Imaging (MSX)	IR image with enhanced detail presentation
Picture-in-Picture	IR area on visual image
Measurement	
Object temperature range	-20°C to +250°C (-4°F to +482°F) 10°C to 550°C (50°F to +1022°F)
Accuracy	±2°C (±3.6°F) or ±2% of reading, for ambient temperature 10°C to 35°C (+50°F to 95°F) and object temperature above +0°C (+32°F)
Measurement analysis	
Spotmeter	Center spot
Area	Box with max./min.
Isotherm	Above alarm, Below alarm
Emissivity correction	Variable from 0.1 to 1.0
Emissivity table	Emissivity table of predefined materials
Reflected apparent temperature correction	Automatic, based on input of reflected temperature
Set-up	
Color palettes	Black and white, iron and rainbow
Set-up commands	Local adaptation of units, language, date and time formats
Storage of images	
File formats	Standard JPEG, 14-bit measurement data included
Digital camera	
Digital camera, resolution	640 × 480
Digital camera, FOV	55° × 43°
Data communication interfaces	
Interfaces	USB Micro: Data transfer to and from PC and Mac device
Wi-Fi	Peer-to-peer (ad hoc) or infrastructure (network)
Radio	
Wi-Fi	<ul style="list-style-type: none"> • Standard: 802.11 b/g/n • Frequency range: <ul style="list-style-type: none"> ◦ 2400–2480 MHz ◦ 5150–5260 MHz • Max. output power: 15 dBm
Power system	
Battery type	Rechargeable Li ion battery
Battery voltage	3.6 V
Battery operating time	Approx. 4 hours at +25°C (+77°F) ambient temperature and typical use
Charging system	Battery is charged inside the camera or in specific charger.



FLIR E6xt (incl. Wi-Fi)

P/N: 63907-0804

© 2019, FLIR Systems, Inc.

#63907-0804; r. 55616;

Power system	
Charging time	2.5 hours to 90% capacity in camera. 2 hours in charger.
Power management	Automatic shut-down
AC operation	AC adapter, 90–260 VAC input, 5 VDC output to camera

Environmental data	
Operating temperature range	–15°C to +50°C (+5°F to +122°F)
Storage temperature range	–40°C to +70°C (–40°F to +158°F)
Humidity (operating and storage)	IEC 60068-2-30/24 h 95% relative humidity
EMC	<ul style="list-style-type: none">EN 61000-6-2 (Immunity)EN 61000-6-3 (Emission)FCC 47 CFR Part 15 Class B (Emission)RCM
Radio spectrum	<ul style="list-style-type: none">ETSI EN 300 328ETSI EN 301 893FCC 47 CFR Part 15 C, ERSS-247 Issue 2
Hazardous substances	<ul style="list-style-type: none">WEEE 2012/19/EURoHs 2011/65/EU
Encapsulation	IP 54 (IEC 60529)
Shock	25 g (IEC 60068-2-27)
Vibration	2 g (IEC 60068-2-6)
Drop	2 m (6.6 ft.)
Safety	Camera: IEC/EN60950-1 Power supply: UL, CSA, CE, PSE, CCC, and SAA

Physical data	
Camera weight, incl. battery	0.575 kg (1.27 lb.)
Camera size (L × W × H)	244 × 95 × 140 mm (9.6 × 3.7 × 5.5 in.)
Color	Black and gray

Shipping information	
Packaging, type	Cardboard box
List of contents	<ul style="list-style-type: none">Infrared cameraHard transport caseBattery (inside camera)USB cablePower supply/charger with EU, UK, US and Australian plugsPrinted documentation
Packaging, weight	2.9 kg (6.4 lb.)
Packaging, size	385 × 165 × 315 mm (15.2 × 6.5 × 12.4 in.)
EAN-13	4743254004016
UPC-12	845188018795
Country of origin	Estonia

Supplies & accessories:

- T911093; Tool belt
- T911689ACC; Pouch for FLIR E-series
- T198528; Hard transport case FLIR Ex-series



FLIR E6xt (incl. Wi-Fi)

P/N: 63907-0804

© 2019, FLIR Systems, Inc.

#63907-0804; r. 55616;

- T198531; Battery charger incl power supply
- T198532; Car charger
- T198534; Power supply USB-micro
- T198529; Pouch FLIR Ex and ix series
- T198533; USB cable Std A <-> Micro B
- T199362ACC; Battery Li-ion 3.6 V, 2.6 Ah, 9.4 Wh
- T198583; FLIR Tools+ (download card incl. license key)
- T199233; FLIR Atlas SDK for .NET
- T199234; FLIR Atlas SDK for MATLAB
- INST-EW-0125; Extended Warranty 1 Year for A5, A15, E6, E8
- INST-EWGM-0120; Premium Service Package for A5, A15, E6, E8
- INST-GM-0120; General Maintenance Package for A5, A15, E6, E8

Camera with built-in IR lens f=6,5 mm (45°)

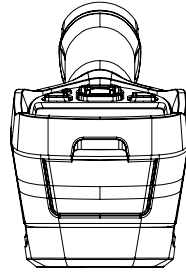
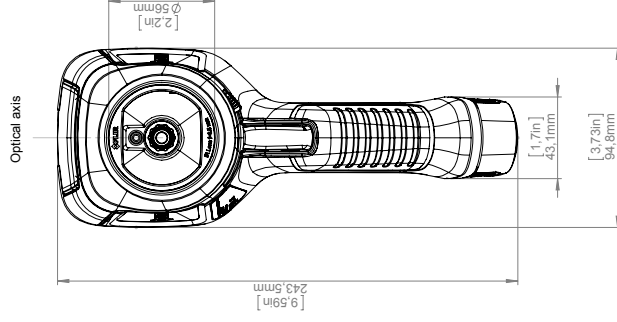
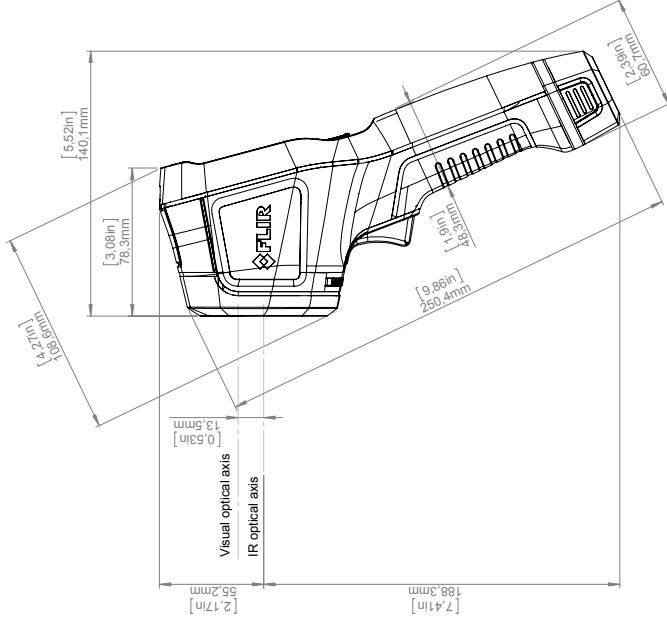
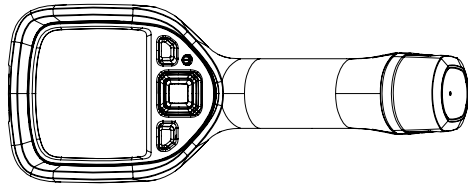
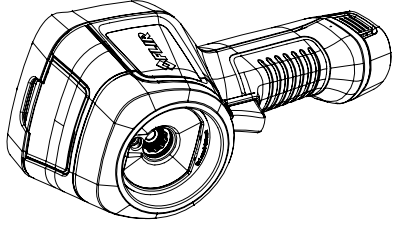
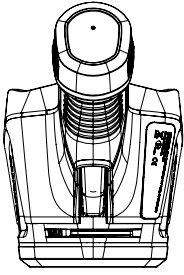

Charger and Power pack

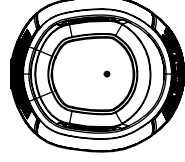
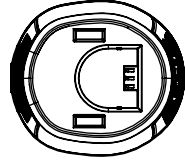
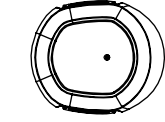
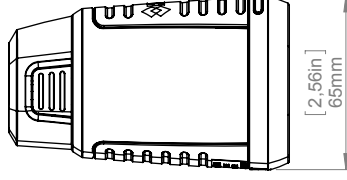
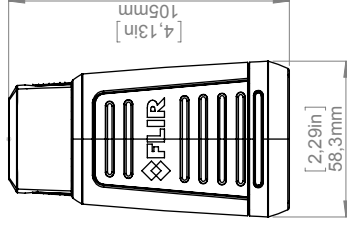
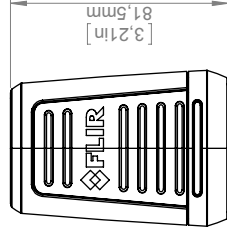
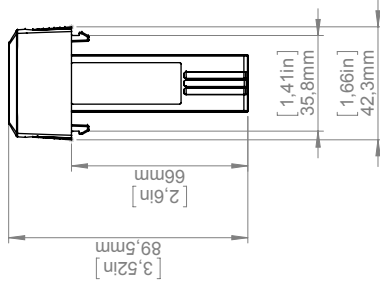
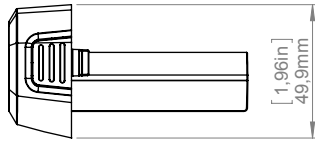
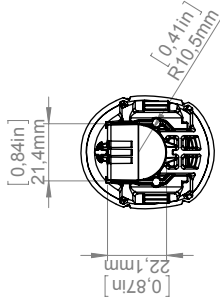
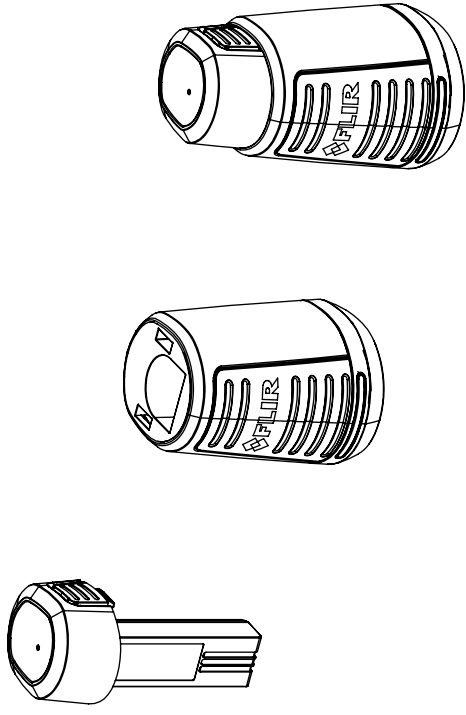

		Size: A3 Scale: 1:2 Drawing No: T127831 Size: A
Modified: 2013-03-25 Denomination:	Check: CAHA	Drawn by: R&D Thermography
Basic dimensions FLIR Ex		

© 2012, FLIR Systems, Inc. All rights reserved worldwide. No part of this drawing may be reproduced, stored in a retrieval system, or transmitted in any form, or by any means, electronic, mechanical, photocopying, recording, or otherwise, without written permission from FLIR Systems, Inc. Specifications subject to change without further notice. Dimensional data is based on nominal values. Products may be subject to regional market considerations. License procedures may apply. Product may be subject to US Export Regulations. Please refer to exportquestions@flir.com with any questions. Division contrary to US law is prohibited.



The World's Sixth Sense™

February 24, 2017 Täby, Sweden

AQ320224

CE Declaration of Conformity – EU Declaration of Conformity

Product: FLIR EX -series

Name and address of the manufacturer:

FLIR Systems AB

PO Box 7376

SE-187 15 Täby, Sweden

This declaration of conformity is issued under the sole responsibility of the manufacturer.

The object of the declaration: FLIR EX -series.

The object of the declaration described above is in conformity with the relevant Union harmonisation legislation:

Directives:

Directive	2014/30/EU	Electromagnetic Compatibility
Directive	2014/35/EU	Low Voltage Directive (Power Supply)
Directive	2012/19/EU	Waste electrical and electric equipment
Directive:	2011/65/EU	RoHS
Directive	1999/5/EC	Radio and Telecommunications Terminal Equipment

Standards:

Emission:	EN 61000-6-3/A1:2011	Electromagnetic Compatibility Generic standards – Emission
Immunity:	EN 61000-6-2:2005	Electromagnetic Compatibility Generic standards – Immunity
Restricted substances (RoHS):	EN 50581:2012	Technical documentation
Radio:	ETSI EN 300 328 ETSI EN 301 893	Harmonized EN covering essential requirements of the R&TTE Directive
Safety (Power supply):	EN 60950	Information technology equipment

FLIR Systems AB
Quality Assurance

Lea Dabiri
Quality Manager